

Penta



nicoline

Descrizione modello - Model Description

Dimensioni - Dimensions

Composizioni consigliate - Recommended compositions

nicoline.it

ITALY - C.da Parchi Calia sn Z.I. - 70022 Altamura – BA - Telefono: +39 080 3101487

UNITED STATES - Nicoline Salotti Inc. po box 38783 - Greensboro – NC 27438 - Phone: +1 (336) 259 9881

SINGAPORE - 23 Genting Road #06-01 - Chevalier House Singapore 349481 - Telefono: +65 8168 3354

PENTA

Design Application N° 008642821-0015



Caratteristiche standard

- Struttura in multistrato, massello di abete e base in MDF con rinforzi in metallo, molleggio seduta e spalliera con cinghie elastiche.
- Imbottiture in poliuretano espanso ecologico a cellula aperta con densità differenziate.
- Cuscini di schienale in fibra "Extra soft".
- Rivestimento in pelle o tessuto con cuscini di seduta e spalliera sfoderabili.
- Elementi Cod.1421 - 1422 - 1671 - 1672 - 3031 - 3032 - 3521 - 3522 con ripiano in marmo Bianco Carrara (Cod.CA).
- Piede (PM001) in metallo Canna di fucile (Cod.50), Ottone satinato (Cod.51), Bronzo anticato (Cod.52).
- Cucitura Cod.01 + Cod.03 per rivestimento in pelle.
- Cucitura Cod.03 per rivestimento in tessuto.
- Inserimento letto non possibile.
- Lato componibile rifinito.

Caratteristiche optional su richiesta senza maggiorazione

- Piede (PM002) in metallo Canna di fucile (Cod.50), Ottone satinato (Cod.51), Bronzo anticato (Cod.52).
- Disponibile con cucitura a contrasto, per la scelta del colore fare riferimento ai codici del campionario pelli.

Caratteristiche optional su richiesta con maggiorazione

- Per il multi rivestimento il prezzo va incrementato del 7%. Per maggiori dettagli fare riferimento al paragrafo "NOTE" posto nelle prime pagine del listino.
- Elementi Cod. 1421 - 1422 - 1671 - 1672 - 3031 - 3032 - 3521 - 3522 con ripiano in marmo Emperador (Cod.EM), Nero Marquinia (Cod.NM).

Note

- I disegni grafici che riportano l'asterisco (*) sono sempre con lato rifinito e anche agganciabili agli elementi componibili.
- Non è possibile applicare altre cuciture.
- Per alcuni tessuti e velluti l'azienda si riserva di applicare la cucitura Cod.00 / Cod.03 (vedi immagine).

Standard features

- Frame: wooden structure, solid fir wood with MDF base with metal reinforcements, seat suspensions in reinforced elastic webbing.
- Paddings in eco-friendly open cell polyurethane foam, with different densities.
- Back cushions in "Extra soft" fiber.
- Covering in leather or fabric. Seat and back cushions coverings removable.
- Versions Cod.1421 - 1422 - 1671 - 1672 - 3031 - 3032 - 3521 - 3522 with top in White Carrara marble (Cod.CA).
- Legs (PM001) in Gunmetal (Cod.50), Satin Brass (Cod.51), Antique bronze (Cod.52).
- Stitching type Cod.01 + Cod.03 for leather covering.
- Stitching type Cod.03 for fabric covering.
- No bed version available.
- Sectional sides finished.

Optional features available upon request without any upcharge

- Legs (PM002) in Gunmetal (Cod.50), Satin Brass (Cod.51), Antique bronze (Cod.52).
- Stitching, unless differently requested, will be matching the leather or fabric colour. Contrast stitching colour can be ordered at no extra charge. You might use as reference any Nicoline leather.

Optional features available upon request with an upcharge

- 7% upcharge for combined coverings. Please refer to the notes at the beginning of pricelist.
- Versions Cod. 1421 - 1422 - 1671 - 1672 - 3031 - 3032 - 3521 - 3522 with top in Emperador marble (Cod.EM), Black Marquinia marble (Cod.NM).

Notes

- Versions with asterisk (*) have always the terminal side finished with the possibility to be connected to modular elements.
- Different stitchings not available.
- For some fabrics and velvets production dept. must apply the stitching Cod.00 / Cod.03 (as per picture below).



Piede in metallo standard (PM001) // Metal leg standard (PM001)



Piede in metallo opzionale (PM002) // Metal leg optional (PM002)



Canna di Fucile (Cod.50) // Gunmetal (Cod.50)



Ottone Satinato (Cod.51) // Satin Brass (Cod.51)

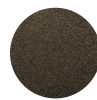

Bronzo Anticato (Cod.52) // Antique Bronze (Cod.52)

Cuciture // Stitching

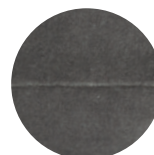

Cod.00

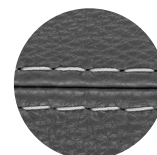

Cod.01

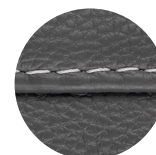

Cod.03

FRONTALE
FRONT

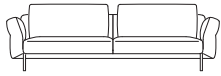

LATERALE
DEPTH

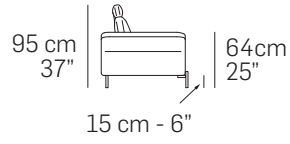
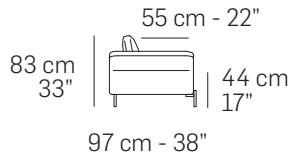

3580

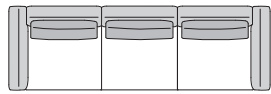

305 cm - 120"

3900

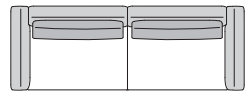

270 cm - 106"

3200

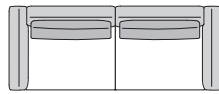

246 cm - 97"

3000

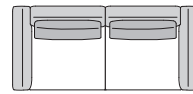

216 cm - 85"

2200

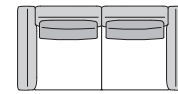

196 cm - 77"

A

1203

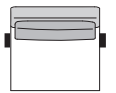

104 cm - 41"

1202

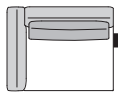

123 cm - 48"

1201

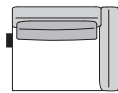

123 cm - 48"

3202

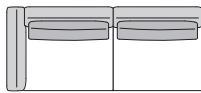

226 cm - 89"

3201

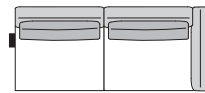

226 cm - 89"

3203

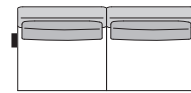

207 cm - 82"

1602

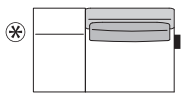

164 cm - 65"

1601

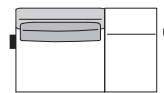

164 cm - 65"

1672



154 cm - 61"

1671

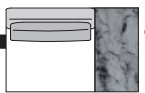

154 cm - 61"

5252

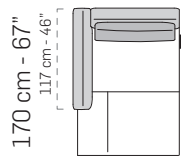

123 cm - 48"

5251

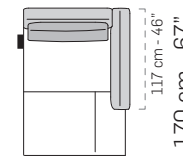

123 cm - 48"

5203

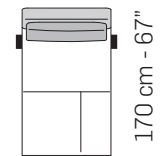

104 cm - 41"

1572

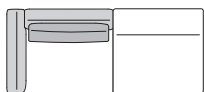

227 cm - 89"

1571

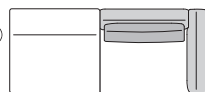

227 cm - 89"

3232

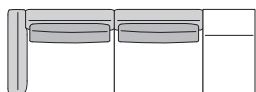

286 cm - 113"

3231

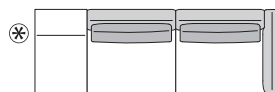

286 cm - 113"

3522

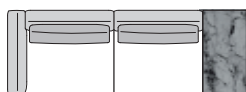

276 cm - 109"

3521

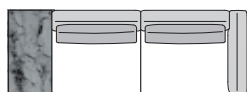

276 cm - 109"

4232

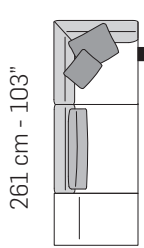

261 cm - 103"

97 cm - 38"

4231

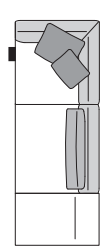

261 cm - 103"

97 cm - 38"

tutti gli elementi del gruppo A hanno lo stesso modulo di seduta - all items in group A have the same seat width

B

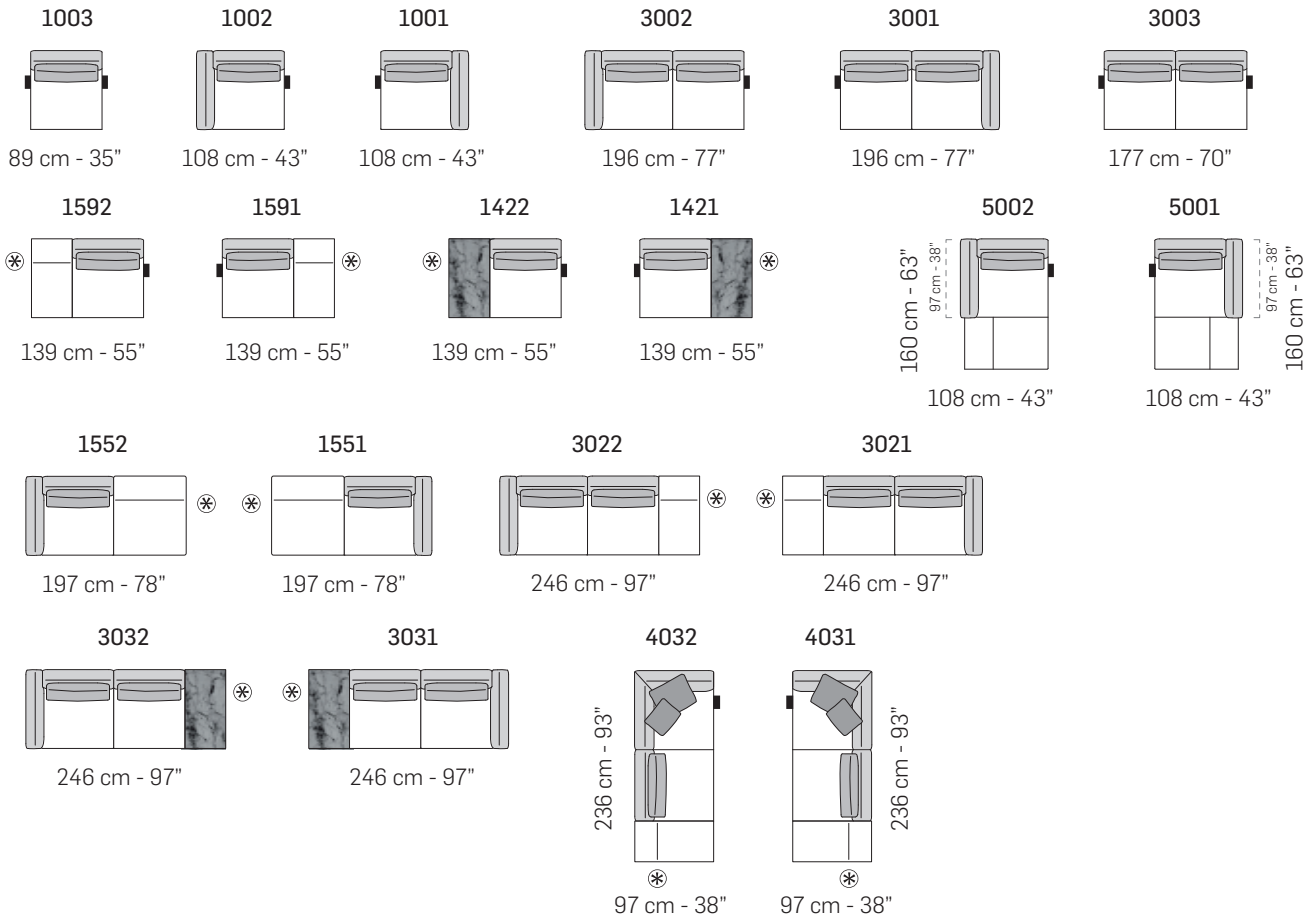

tutti gli elementi del gruppo B hanno lo stesso modulo di seduta - all items in group B have the same seat width

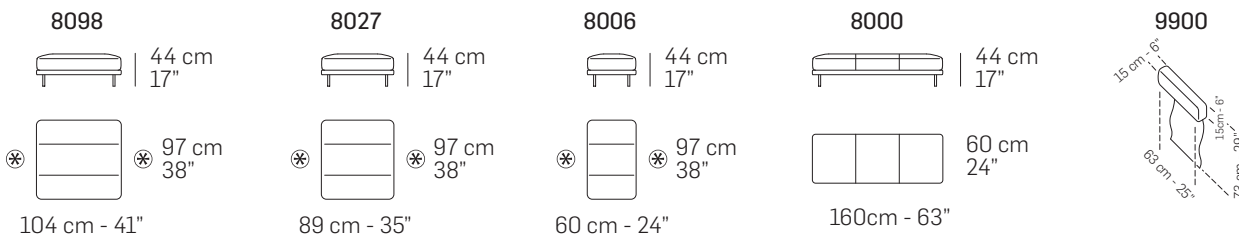
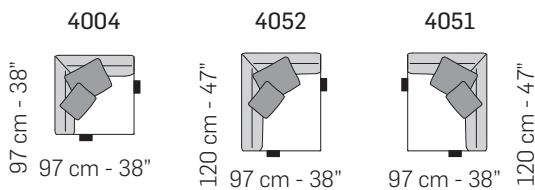

CUSCINETTI CONSIGLIATI / SUGGESTED PILLOWS

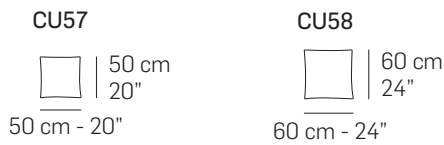

COMPOSIZIONI CONSIGLIATE / SUGGESTED COMPOSITIONS

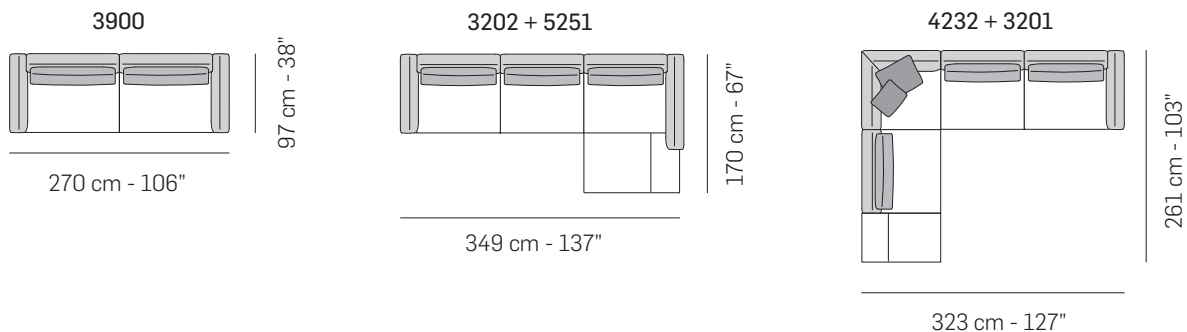

Scala 1:100
Ratio 1 to 100

Legenda / Legend

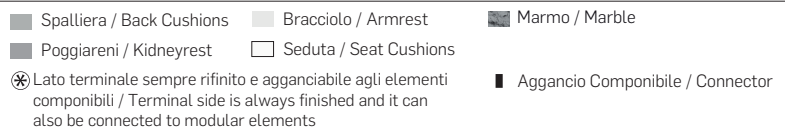

Note / Notes

Nicoline si riserva il diritto di apportare in ogni momento modifiche tecniche ed estetiche / Nicoline reserves the right to change, at any time and without prior warning, technical and aesthetic specifications of the articles.