

Antares Leg



nicoline

Descrizione modello - *Model Description*

Dimensioni - *Dimensions*

Composizioni consigliate - *Recommended compositions*

nicoline.it

ITALY - C.da Parchi Calia sn Z.I. - 70022 Altamura – BA - Telefono: +39 080 3101487

UNITED STATES - Nicoline Salotti Inc. po box 38783 - Greensboro – NC 27438 - Phone: +1 (336) 259 9881

SINGAPORE - 23 Genting Road #06-01 - Chevalier House Singapore 349481 - Telefono: +65 8168 3354

ANTARES LEG

Design Application N° 40202000002749

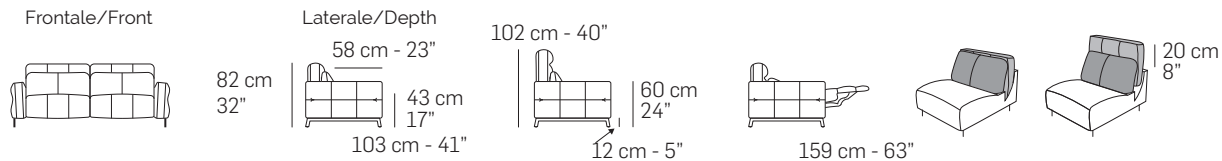

Caratteristiche standard

- Struttura in legno e multistrato, molleggio seduta e schienale con cinghie elastiche.
- Imbottiture in poliuretano espanso ecologico a cellula aperta con densità differenziate.
- Rivestimento in pelle o tessuto. Tutti i rivestimenti sono fissi.
- Piede in metallo Canna di fucile (Cod.50), Bronzo anticato (Cod.52).
- Versioni fisse con meccanismo poggiatesta elettrico che aumenta l'altezza dello stesso di cm 20.
- Versioni recliner con meccanismo elettrico sia per la seduta che per il poggiatesta.
- Tutte le versioni contrassegnate dal simbolo "↑", sono dotate di poggiatesta regolabile elettricamente.
- Cucitura Cod.01 - 03 per rivestimento in pelle.
- Cucitura Cod.03 per rivestimento in tessuto.
- Inserimento letto non possibile.
- Lato componibile non rifinito.

Caratteristiche optional su richiesta senza maggiorazione

- Piede in legno verniciato nei colori standard Noce (Cod.02), Wengè (Cod.05).
- Disponibile con cucitura a contrasto, per la scelta del colore fare riferimento ai codici del campionario pelli.

Caratteristiche optional su richiesta con maggiorazione

- Batteria al litio per movimentare il meccanismo in assenza di elettricità. Considerare una batteria per ogni seduta recliner o schienale motorizzato.
- Solo per le versioni dove previsto, il lato componibile può essere rifinito.
- Per il multi rivestimento il prezzo va incrementato del 7%. Per maggiori dettagli fare riferimento al paragrafo "NOTE" posto nelle prime pagine del listino.

Note

- Le versioni recliner sono consegnate a moduli separati.
- Si consiglia di non comporre fra loro i moduli A - B in quanto le sezioni di divisione della seduta/schienale hanno dimensioni diverse fra i vari gruppi.
- Non è possibile applicare altre cuciture.
- Per alcuni tessuti e velluti l'azienda si riserva di applicare la cucitura Cod.00 / Cod.03 (vedi immagine).

Standard features

- Frame: wooden structure, seat and back suspensions in reinforced elastic webbing.
- Paddings in eco-friendly open cell polyurethane foam, with different densities.
- Covering in leather or fabric. Not removable coverings.
- Legs in Gunmetal (Cod.50), Antique bronze (Cod.52).
- Stationary versions with electric mechanism for the headrest which allows to increase its height of cm 20.
- Reclining versions with electric mechanism for both seat and headrest.
- All the versions marked by the symbol "↑" are equipped with electric adjustable headrest.
- Stitching type Cod.01 - 03 for leather covering.
- Stitching type Cod.03 for fabric covering.
- No bed version available.
- Sectional sides not finished.

Optional features available upon request with no upcharge

- Beech wooden leg painted in standard colors Walnut (Cod.02), Wengè (Cod.05).
- Stitching, unless differently requested, will be matching the leather or fabric colour. Contrast stitching colour can be ordered at no extra charge. You might use as reference any Nicoline leather.

Optional features available upon request with upcharge

- Lithium battery to move the mechanism in the absence of electricity. Please consider one battery per recliner seat or motorized backrest.
- Sectional sides finished (if possible).
- 7% upcharge for combined coverings. Please refer to the notes at the beginning of pricelist.

Notes

- All reclining versions are made and delivered as separate elements.
- We would suggest choosing versions from the same group and not to combine versions from group A - B, as items from each group have different seat width.
- Different stitchings not available.
- For some fabrics and velvets production dept. must apply the stitching Cod.00 / Cod. 03 (as per picture below).



Piede in metallo // Metal leg



Canna di Fucile (Cod.50) // Gunmetal (Cod.50)



Bronzo Anticato (Cod.52) // Antique Bronze (Cod.52)



Piede in legno // Wooden leg



Noce (Cod.02) // Walnut (Cod.02)



Wengè (Cod.05) // Wengè (Cod.05)

Cuciture // Stitching

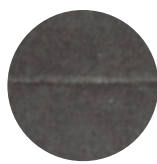

Cod.00

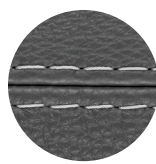

Cod.01



Cod.03

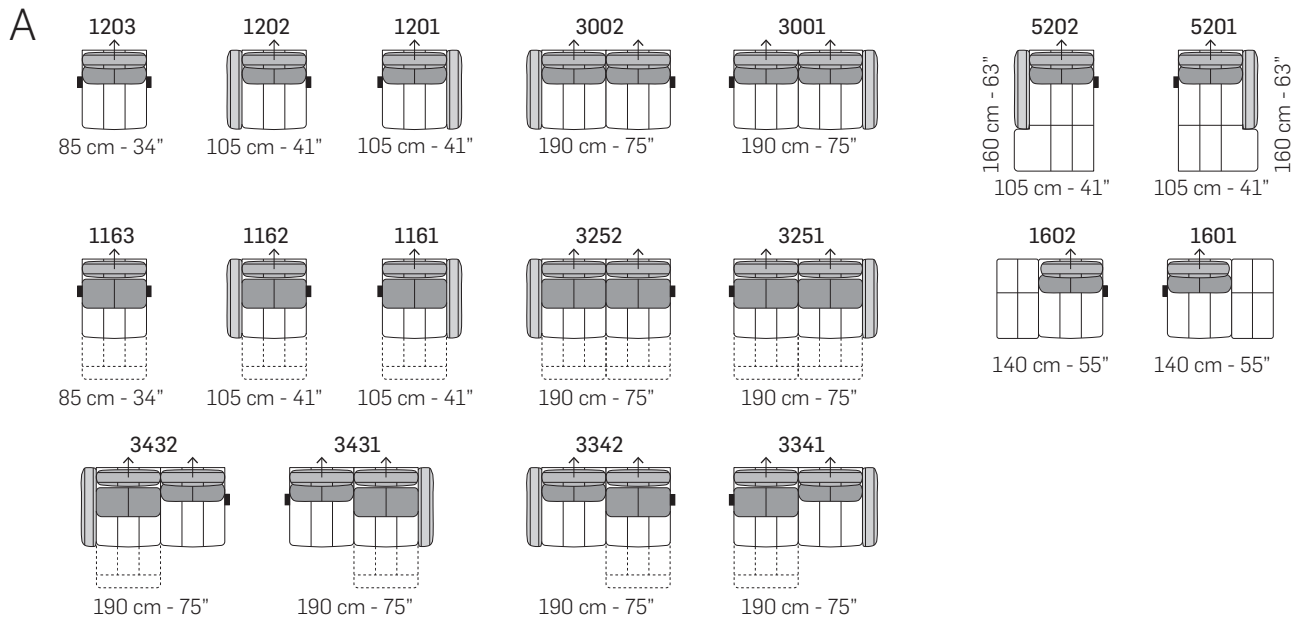
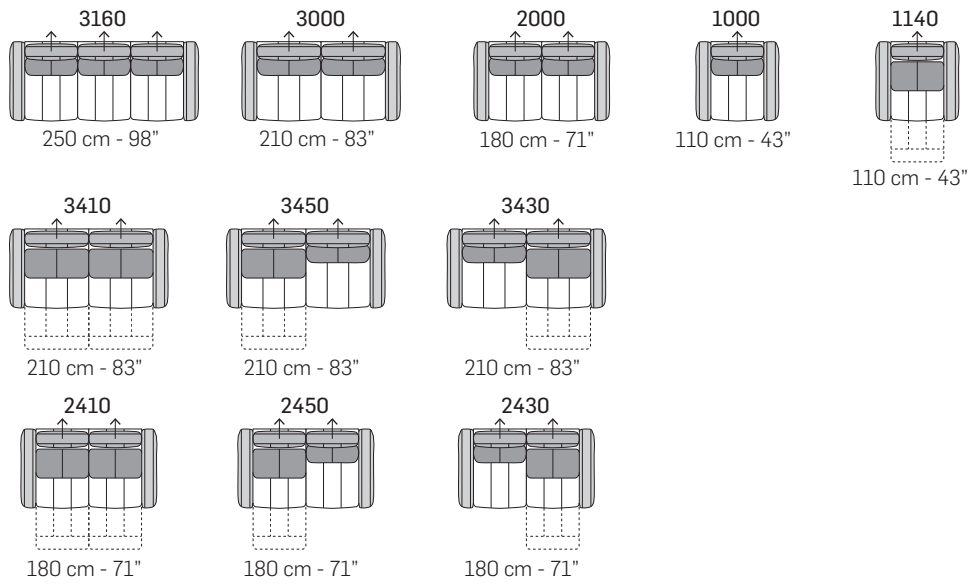

tutti gli elementi del gruppo A hanno lo stesso modulo di seduta - all items in group A have the same seat width

B

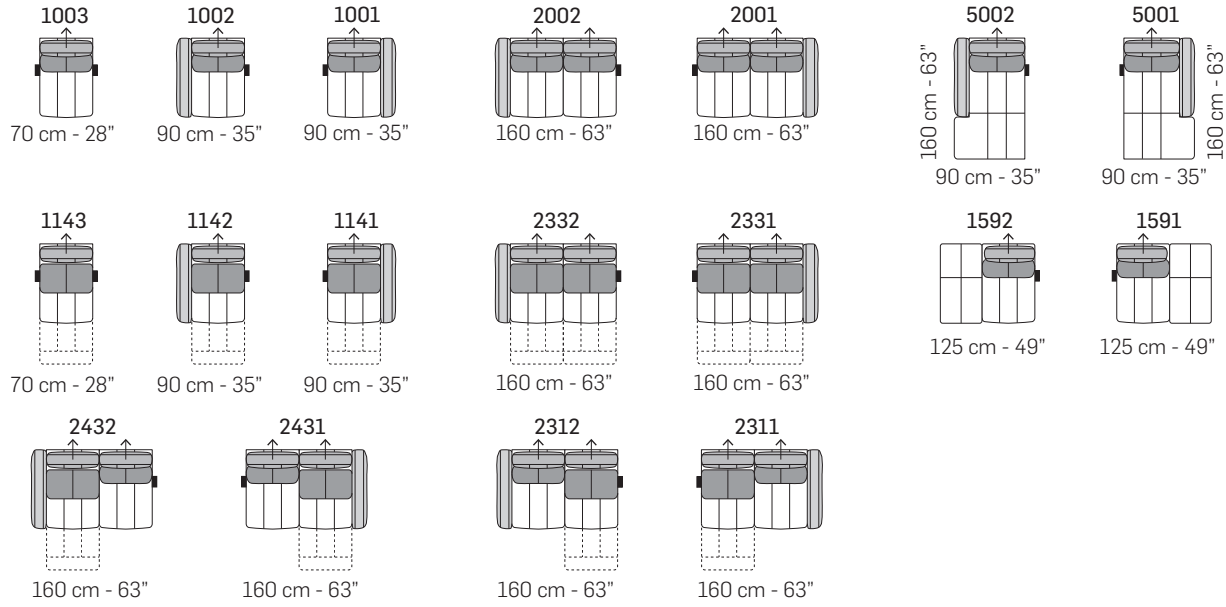

tutti gli elementi del gruppo B hanno lo stesso modulo di seduta - all items in group B have the same seat width

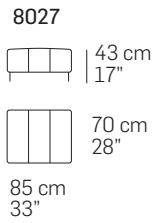
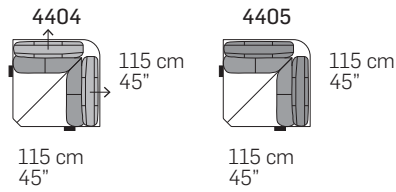

COMPOSIZIONI CONSIGLIATE / SUGGESTED COMPOSITIONS

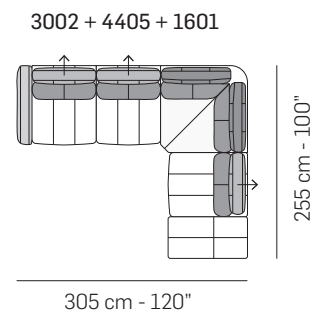
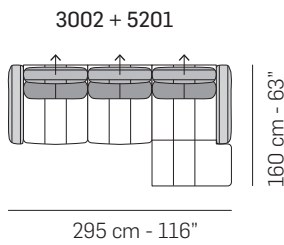
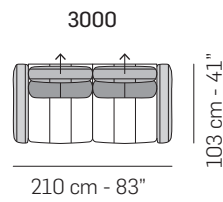

Scala 1:100
Ratio 1 to 100

Legenda / Legend

- Spalliera / Back Cushions
- Bracciolo / Armrest
- Aggancio Componibile / Connector
- Poggiareni / Kidneyrest
- Seduta / Seat Cushions
- Poggiatesta fisso / Fixed headrest
- ↑ Poggiatesta regolabile / Adjustable headrest

Note / Notes

Nicoline si riserva il diritto di apportare in ogni momento modifiche tecniche ed estetiche / Nicoline reserves the right to change, at any time and without prior warning, technical and aesthetic specifications of the articles.